

Fig. 4

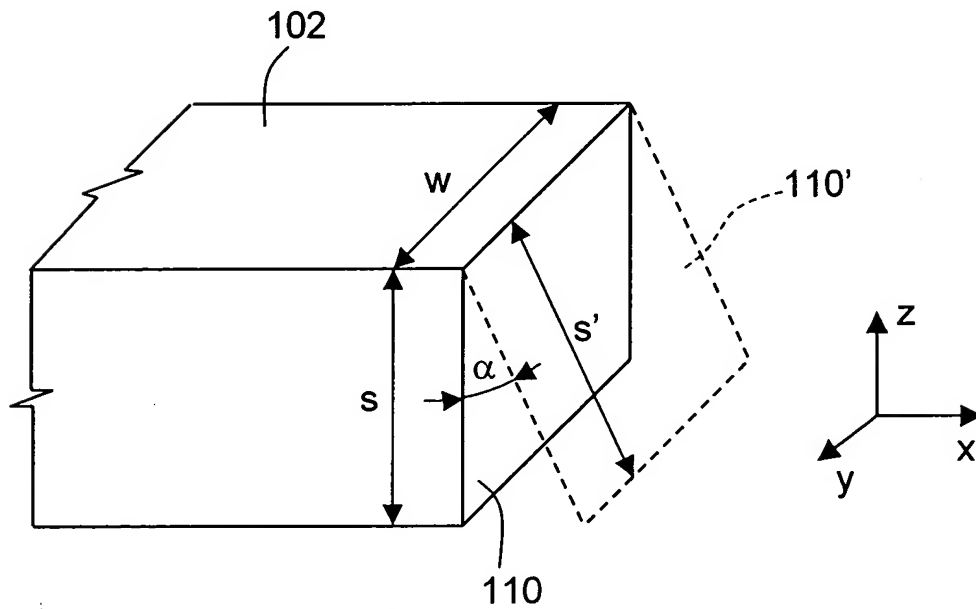

Fig. 5